

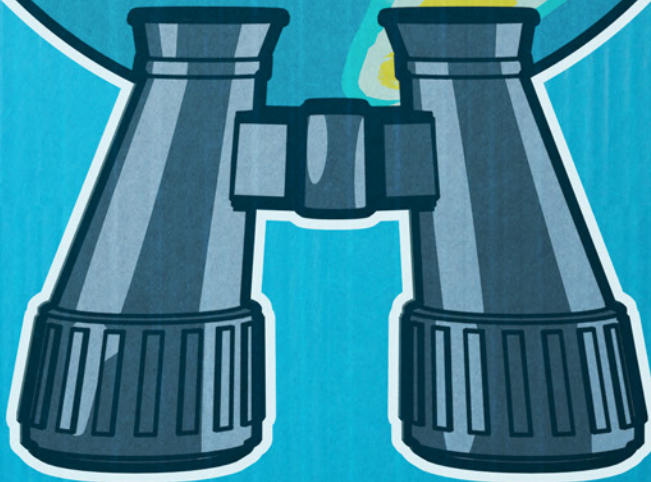

INVESTMENT
INSIGHTS
INCLUDED!

LPL FINANCIAL RESEARCH
**2015 MIDYEAR
OUTLOOK***

▲ OPEN HERE ▼



*** SOME ASSEMBLY REQUIRED**

| This Package Contains: | | |
|------------------------|------------------------|----------------------|
| Quick Start ...4-5 | International... 10-13 | Bonds..... 18-21 |
| Economy.....6-9 | Stocks 14-17 | Diversify..... 22-25 |



NET WT 4LBS 12OZ
(76OZ) 2.15KG

LPL Financial



SOME
ASSEMBLY
REQUIRED



INSTRUCTION MANUAL

A NOTE BEFORE
YOU BEGIN

In your hands is the *LPL Research Midyear Outlook 2015*, with the insights and guidelines you've been waiting for to put together portfolio strategies for the rest of 2015. Few things can dampen the excitement of seeing the delivery of a long-awaited package on the porch than three words — "some assembly required."

Whether it is navigating the confusing instruction manual, sweating through the complicated assortment of parts, or the sinking feeling that you don't have the right batteries in the closet, sometimes the hard work comes after the delivery truck has driven off. And like any complex assembly, whether it's a 1,000-piece puzzle, a kid's shiny new bike, or a plan to navigate tricky economic times, the amount of pieces to collect and put together can be daunting. But the assembly can certainly be made easier with a well-formulated plan, the right tools, and the *LPL Research Midyear Outlook 2015: Some Assembly Required* as the blueprint for success.

The economy has delivered six consecutive calendar years of positive returns for stocks since the end of the 2008–2009 Great Recession, as measured by the S&P 500 Index; however, constructing a strategy for the remainder of the economic expansion will require a tricky assembly. Divergent monetary policies reveal an uneven global recovery that has triggered an uptick in stock market volatility. A few important pieces requiring assembly for the remainder of 2015 include:

- **How the U.S. economy pieces together the components needed to bounce back from its lackluster start of the year.** The U.S. economy hit an unexpected soft patch to start the year due to a severe winter freeze, the West Coast port strikes, ongoing effects of lower oil prices, and the surging U.S. dollar. Returning to a more normalized 3% growth level will be crucial to build further upon the market's first half gains.

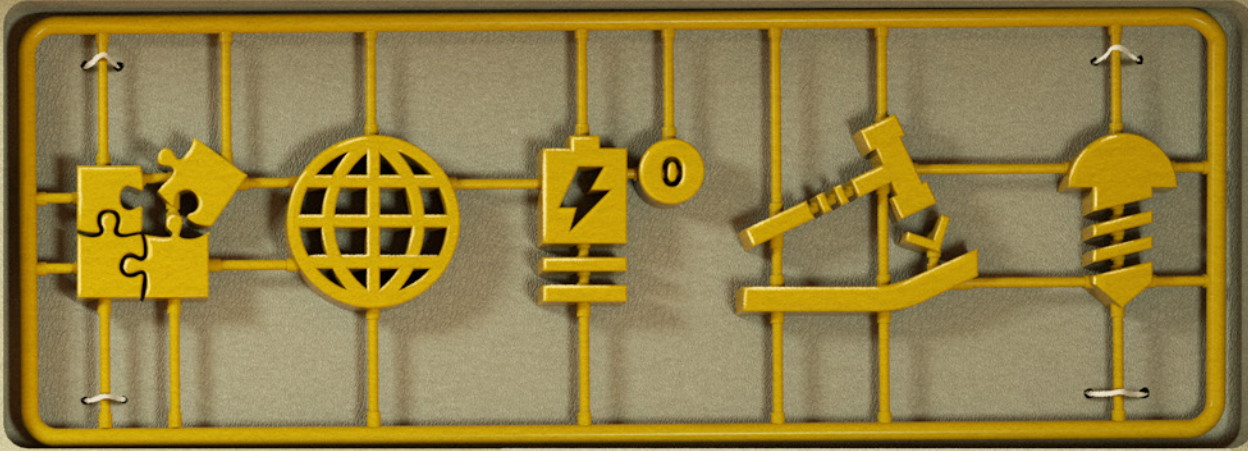

- **After successfully delivering the U.S. economy out of the recessionary “warehouse,” how does the Federal Reserve (Fed) assemble an exit strategy from its six-year policy of zero interest rates?** With unprecedented levels of accommodative monetary policy rendering any traditional instruction manual pointless, the Fed will have to use its entire toolbox to construct a delicate increase in interest rates without disrupting the fragile economic growth and the wavering confidence of businesses, consumers, and investors.
- **Corporate earnings growth continues to search for that spark to ignite equity advances.** In the U.S., lackluster profits aligned with weak first quarter 2015 economic growth to produce the lowest level of year-over-year corporate earnings growth in 11 quarters. Overseas markets are looking for a power boost from the very accommodative monetary policies of global central banks across Europe and Asia, in an attempt to spur sustainable growth, improve earnings, and avoid deflationary forces.

Although there are many packages still in transit as we approach the midpoint of 2015, the biggest challenge for the market is putting the necessary pieces together to construct the backdrop for solid global economic growth, stable prices and currencies, and expanding corporate profits. The task is complicated by the Fed’s expected first interest rate increase in nine years later this year. The assembly will not be an easy one, but the *LPL Research Midyear Outlook 2015: Some Assembly Required* provides the investment instruction manual, tools, and tactics to assemble portfolio strategies that may flourish in a market that remains in transition.



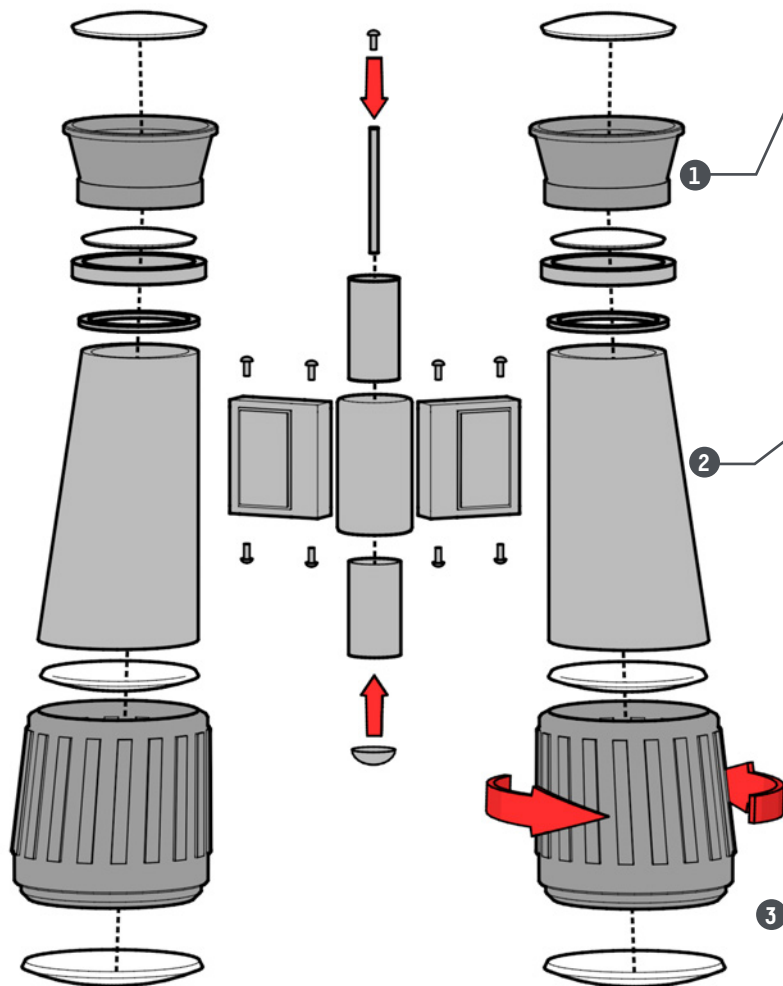

CENTRAL BANK WATCH

Actions by the Fed to exit its accommodative zero interest rate monetary policy appear to be on the horizon for later this year. Assuming that we attain our forecast of 3% GDP growth rate over the rest of 2015, which may push inflation toward 2%, we would anticipate action by the Fed. However, we expect that other central banks will diverge from this path and continue to be accommodative with their monetary policies over the remainder of the year.

DIVERSIFICATION COMING BACK

Diversification did not help portfolio returns in 2014, but the beginning of 2015 witnessed the return of diversification benefits. With volatility poised to rise in the second half of 2015, the potential benefits of diversification—greater portfolio returns with a smoother ride—should hopefully continue to materialize.

BULL MARKET CONTINUES

In the stock market, 2015 has felt like déjà vu. In 2014, the year began with a tough first quarter and finished strong. After a weak start to the year, we believe that corporate America will provide a much needed boost for the second half and 2015 may also finish strong—providing the seventh year of positive returns, in the 5–9% range we forecast.

+ **ECONOMY**

3%
GROWTH

Consumer and business spending may lead U.S. economic growth to its highest annual advance since 2010.

+ **STOCKS**

5-9%
RETURNS

Tempered by increasing levels of volatility, stocks are poised to advance mid- to high-single digits on the back of steady earnings growth.

+ **BONDS**

FLAT
RETURNS

Battling the dual threats of the Fed's impending rise in rates and expanding economic growth, bonds offer very limited return potential in 2015.

PARTS LIST

As the business cycle transitions into its second half and the cross-currents of volatile, disjointed global economic growth abound, navigating the assortment of pieces and using the proper tools will be vital to assembling an investment strategy positioned for success.



RECOMMENDED UPGRADES

Emerging ideas poised to bring wattage to investment portfolios

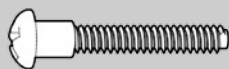

EMERGING MARKET STOCKS
Benefit from attractive valuations and improved global growth.



DEVELOPED INTERNATIONAL (LARGE FOREIGN) STOCKS
Stimulus-driven policies fuel economic recovery.



MANAGED FUTURES ALTERNATIVE STRATEGIES
Cross-currents of currency and commodity price volatility offer opportunities.



CORE CONNECTIONS

Fundamental pieces holding together a successful portfolio strategy

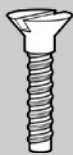

LARGE CAP U.S. STOCKS
Benefit from scale, pricing power, and strong balance sheets.



CYCLICAL GROWTH STOCKS
Improved business spending fuels growth.

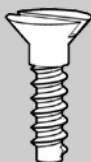

INVESTMENT-GRADE CORPORATE AND HIGH-YIELD BONDS
Higher yields offset potential rate advances.



MUNICIPAL BONDS
Tax benefits and attractive valuations.

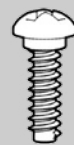

GLOBAL MACRO ALTERNATIVE STRATEGIES
Reduced correlations across the global macro environment may open up favorable investment opportunities.



EXPENDABLE PARTS

Remaining investment pieces offering limited opportunity when added to portfolios



U.S. DEFENSIVE STOCKS
Strong U.S. growth favors cyclicals over the often more interest rate-sensitive defensive sectors.



LONG-TERM HIGH-QUALITY BONDS
Backdrop of rising rates impedes opportunity.



INTERNATIONAL DEVELOPED MARKET (FOREIGN) BONDS
Historically low yields offer limited opportunities.



COMMODITIES
Stronger dollar limits growth prospects.

ADVANCE WARNING: FIVE FORECASTERS

LPL Research is always on recession watch and we use our Five Forecasters as the advance warning system. These five data series have a significant historical record of providing a caution signal that we are transitioning into the late stage of the economic cycle and that recessionary pressures are mounting. Despite the aging of the current economic expansion, the Five Forecasters are suggesting a low probability of a near-term recession.

| FORECASTER | LATE-CYCLE WARNING? | | | SIGNAL |
|--------------------------------|----------------------------------|----------------------------------|-----------------------|--|
| | NO | ON WATCH | YES | |
| TREASURY YIELD CURVE | <input checked="" type="radio"/> | <input type="radio"/> | <input type="radio"/> | A 3-month Treasury yield more than 0.5% above the 10-year Treasury yield. |
| LEADING ECONOMIC INDICATORS | <input checked="" type="radio"/> | <input type="radio"/> | <input type="radio"/> | A year-over-year decline in the Conference Board's Leading Economic Index. |
| MARKET BREADTH | <input checked="" type="radio"/> | <input type="radio"/> | <input type="radio"/> | The NYSE Composite Index is making new highs, but the NYSE advance-decline line, a cumulative measure of the net number of stocks rising, is in a technically confirmed downtrend. |
| PURCHASING MANAGERS' SENTIMENT | <input type="radio"/> | <input checked="" type="radio"/> | <input type="radio"/> | A clear peak in the Institute for Supply Management's (ISM) Purchasing Managers' Index (PMI) signals a likely peak in the earnings growth rate. We believe the impact is already reflected in earnings. |
| MARKET VALUATION | <input type="radio"/> | <input checked="" type="radio"/> | <input type="radio"/> | A price-to-earnings ratio (PE) for S&P 500 on trailing operating earnings over 17. However, once there, it can stay elevated for long periods of time. Low interest rates and other factors support higher valuations. |

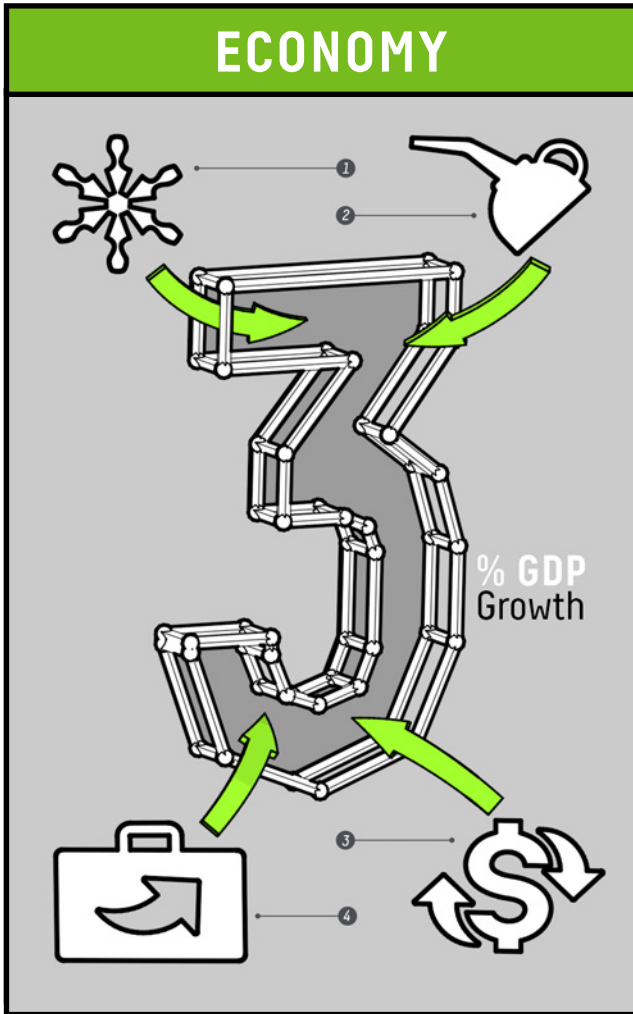

STEP 1:

PUTTING THE PIECES TOGETHER

U.S. Economy Restarts Its Growth Climb

We continue to expect that the U.S. economy will expand at a rate of 3% or slightly higher over the remainder of 2015, once economic conditions recover from yet another harsh winter—and other transitory factors—that held back growth in the early part of 2015. This forecast matches the average growth rate over the past 50 years, and is based on contributions from consumer spending, business capital spending, and housing, which are poised to advance at historically average or better growth rates in 2015. Net exports and the government sector should trail behind.

Overseas, ongoing quantitative easing (QE) by the European Central Bank (ECB) will help to anchor the nascent economic recovery in the Eurozone, while easing already put in place from the Bank of Japan (BOJ) should secure acceleration in Japan’s economy in the second half of the year. In China, growth has slowed from the unsustainable 10–12% pace seen in the first decade of the 2000s to around 7% this year, but we continue to expect Chinese policymakers to use all the tools in their toolbox (monetary, fiscal, and regulatory) to hit the 7% growth target. For more on our thoughts on the global economy, see our international section, “Be Careful Not to Overtighten.”

Expansion Sets Available

After the weather-induced slow start to 2014, the U.S. economy—as measured by growth in real gross domestic product (GDP)—pieced together a solid final three quarters, as annualized GDP growth averaged nearly 4.0%.* As 2015 began, the economy appeared to have built up some much needed momentum, with GDP posting growth of 2.5% or more in 6 of the prior 10 quarters through the fourth quarter of 2014.

But another harsh winter, particularly in the eastern U.S., a major port strike that disrupted trade, and sizable cuts to business capital spending in the energy sector, along with the stronger dollar, combined to secure a decline in GDP growth in the first quarter of 2015.* These transitory factors have begun to fade, starting with improving weather and the end to the port strikes, and potentially extending to the stabilization of the U.S. dollar and oil prices.

Outside of the Eurozone, China, and Japan, central banks that rushed to cut rates in early 2015 to get ahead of the ECB are likely to be more cautious with that tool in the second half of 2015. This may allow the surge in the dollar versus the currencies of its major trading partners to ease and even start to reverse some of the sharp rise seen between mid-2014 and mid-2015. The stabilization of the

* GDP data from Q1 2012 to Q1 2015 are subject to revision on July 30, 2015.

dollar, a pickup in global growth, and oil production cuts in the U.S. and elsewhere may lead to oil prices building on the gains made in the early spring of 2015, after a sharp 40% drop from June 2014 through March 2015.

As temporary challenges from the first quarter fade, we expect the economy to reaccelerate. Key drivers of improvement include a bounce back in business capital spending, an acceleration in housing, improving exports (as overseas economies accelerate), and ongoing solid performance of the “good old American know-how” economy, which saw little or no impact from the factors listed above in the first quarter of 2015.

Since the beginning of the current economic expansion in the second quarter of 2009, the good old American know-how economy has outperformed the “old” economy by a sizable margin [Figure 1]. Looking ahead, the competitive advantage of the U.S. in the service sector, including good old American know-how, should help continue to drive economic activity and employment higher in this sector, especially in areas that require advanced skills. U.S. reliance on exports (and employment) in the less volatile service sector, which continues to be in high demand in fast-growing emerging markets worldwide, should help promote longer U.S. economic expansions. Less dependence on the boom-and-bust inventory cycles that accompany more goods-based, export-dependent economies around the world is an additional positive contributing factor for the U.S. economy. Good old American know-how is our most abundant resource

and should continue to make the U.S. an attractive destination for the world’s capital.

If our forecast of 3.0%+ GDP growth over the remainder of 2015 is met, the economy will enter its seventh year of expansion in June 2015, and by the end of the year would become the fourth-longest economic expansion since World War II (WWII) at 78 months. The current recovery is already longer than the average economic recovery duration of 58 months.

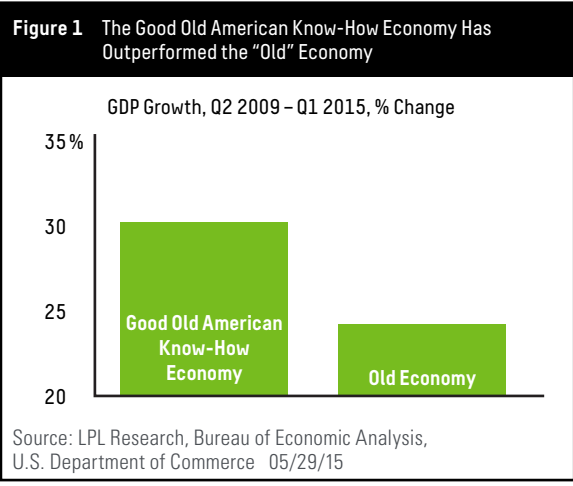

Good old American know-how is measured by the combined GDP of transportation and warehousing; finance and insurance; professional and business services; and arts, entertainment, recreation, accommodation, and food services. The “old” economy refers to manufacturing, and is measured by goods production ex-mining.

WHAT IS GOOD OLD AMERICAN KNOW-HOW?

U.S. top service exports — business, professional, and technical services — is otherwise known as good old American know-how. This includes a wide range of fields such as education, oil field services, entertainment, advertising, computer and information services, research, development, and testing services.

Service exports are basically invisible to average Americans unless they, or someone they know, work in these fields. Unlike many other measures of employment, service exports completely recovered from the Great Recession, and did so in late 2012, 18 months earlier than overall employment.

Perhaps the best comparisons for the current expansion may be the three economic expansions since the end of the inflationary 1970s, a period that has seen the transformation of the U.S. economy from a domestically focused, manufacturing economy to a more import-heavy, services-based, “knowledge” economy.

The last three expansions, which began in 1982, 1991, and 2001, respectively, lasted an average of 95 months, or roughly eight years. By that measure, the current economic expansion still has room to build on the progress made so far, given the lack of economic imbalances that typically herald the end of an economic expansion. Regardless, this economic expansion has likely entered its latter half, which is not only marked by strong economic growth, but also the potential for rising inflation, accelerating wage growth, and eventual Fed rate hikes.

Wage Growth & Inflation Are on Back Order

The labor market is a lagging indicator of overall economic activity. The current economic expansion began in June 2009, but the private sector economy did not regularly begin creating jobs until early 2010. The economy has since added 12 million jobs, with more than 3 million created in the 12 months ending in May 2015 alone, or approximately 250,000 jobs per month. If GDP growth achieves our 3% forecast over the remainder of 2015, the economy should routinely create between 200,000 and 250,000 jobs per month—as it has during the middle of every business cycle over the past 30 years when economic growth was between 3% and 4%—with wage growth rising from around 2% in early 2015 to closer to 3% by the end of 2015. We expect jobs, and therefore economic growth, will be concentrated in the areas of the economy that focus on good old American know-how. In addition, the continued stabilization of oil prices in the second half of 2015 may provide some relief to labor markets and regional economies of the hard hit oil patch.

Although rising wages and inflation often begin to emerge as the business cycle ages, many more factors are still pushing down on inflation than lifting it higher, both in the U.S. and globally. Just as inflation traveled across the globe in the 1960s, 1970s, and early 1980s, the risk of deflation is doing the same in the 2010s. The tepid pace of the current economic expansion in the U.S.—combined with intermittent economic growth in Europe and Japan, and a decelerating Chinese economy—has maintained the threat of deflation. Furthermore, a rising dollar and a sharp drop in commodity prices over the past year have left many economies on the brink of deflation.

Inflationary pressures may nonetheless build over the second half of the year and beyond, supported by stronger U.S. economic growth, loose monetary policy, and normalizing commodity prices. Weak productivity growth over the first six years of the current expansion—influenced in part by the subpar pace of capital spending—may also increase the likelihood of inflation, as productivity growth determines how fast an economy can expand without creating inflationary pressures.

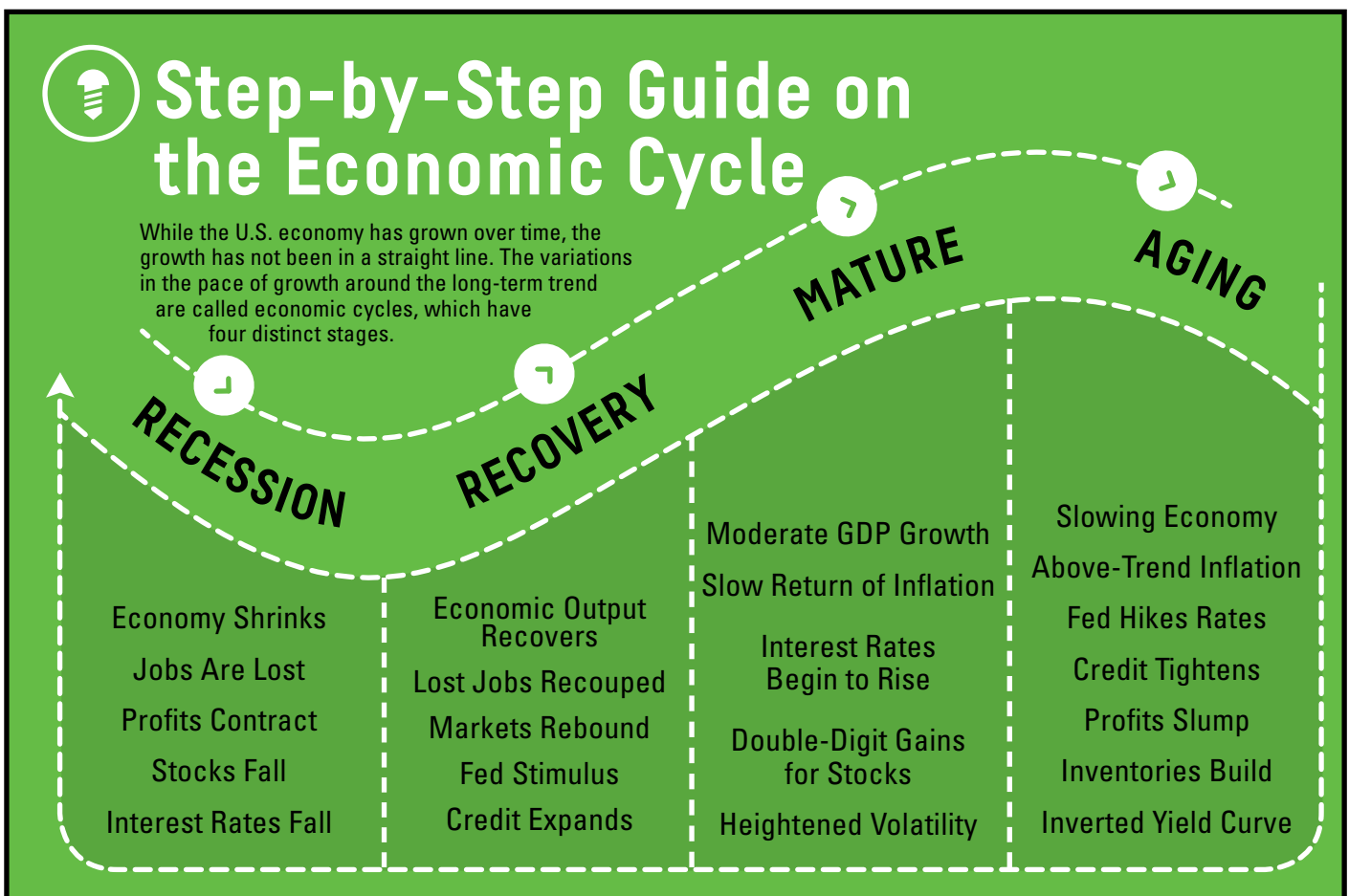

Figure 2 Since 2010, Service Sector Inflation Has Continued to Accelerate, While Goods Inflation Has Decelerated Sharply



Shaded areas indicate recession.

The Consumer Price Index (CPI) is a measure of the average change over time in the prices paid by urban consumers for a market basket of consumer goods and services.

Beneath the surface of the disinflationary environment (a period characterized by rising prices, but at a slower rate than in the past), some inflation never disappeared. Service sector inflation has accelerated since 2010 and remains poised to potentially move even higher as the economy accelerates [Figure 2], even though goods inflation (commodities, clothing, food, etc.) decelerated sharply in recent years. We continue to expect a modest

acceleration in inflation over the second half of 2015, enough to make the Fed “reasonably confident” that inflation will head back to its 2.0% target.

Based on the forward-looking economic data, the odds of a recession in the second half of 2015 or in 2016 are still low, but we remain vigilant for signs that the imbalances typically leading to recessions are beginning to build.



What Does a Fed Rate Hike Look Like? Lower and Slower for Longer

| | | |
|---|------------------|--|
| ✓ | WHEN? | Action by the Fed will be a reaction to key data hitting predetermined targets. We anticipate the first move at the end of 2015. Maximum employment = 250,000 jobs created per month and employment rate of 5.4%. Inflation = Fed is reasonably confident inflation will move back toward 2% in medium term. |
| ✓ | HOW MUCH? | The first hike is expected to be 0.25%, with a very low probability of 0.50%. |
| ✓ | HOW FAST? | Longer run is 3.75%, but that is years out (as the market expects only 2% by 2018). |

INTERNATIONAL

TIPS & SUGGESTIONS:

BE CAREFUL NOT TO OVERTIGHTEN

Overseas, monetary policies hammered out in early 2015, and what we expect to be enacted over the remainder of 2015, are big potential drivers of global growth, impacting most of the largest international economies. While the U.S. is close to tightening its monetary policy bolts following the recovery from the Great Recession, the majority of global central banks are not ready to pick up their screwdrivers and start tightening.

Europe:

Progressing Toward a More Fully Assembled Economy

Clarity on the direction of the Eurozone economy is finally emerging for the first time in almost a decade. Following two recessions since 2007, the ECB embarked on a major QE program in early 2015 to pump more than \$1 trillion into the still splintered European banking system by September 2016.

The Eurozone's financial transmission system—which allows credit to flow from the ECB, to banks and financial institutions, and finally to businesses and households—was badly damaged in the Great Recession and its aftermath. In late 2014, the banking system started to heal in anticipation of ECB QE, as money supply growth and bank lending picked up [Figure 3]. Work still needs to be done in securing Europe's economic future with a stronger banking system, more flexible labor markets, perhaps fiscal stimulus, and clarity on Greece's status in the Eurozone. However, progress toward a more fully assembled Eurozone economy has begun and Europe could add to global growth in 2015, especially if the ECB keeps the monetary policy bolts quite loose for the foreseeable future.

Japan:

Charging Up for Acceleration in 2015

We expect Japan's economy to continue to accelerate in 2015, aided by the BOJ's aggressive QE program, fiscal stimulus, and efforts by the Japanese government to ease regulatory and structural burdens on the economy. Japan's economy has been buffeted by deflationary forces for nearly three decades, but the strong policy response from Japan's government and central bank has begun to build a firewall against those forces in recent years [Figure 4]. The BOJ signaled markets it will continue to give the current dose of stimulus more time to work through the system, and therefore additional stimulus is unlikely in 2015.

We remain skeptical of the BOJ's ability to drive sustainable long-term improvement in growth, given Japan's demographic challenges and long history of deflationary pressures. However, a weaker yen along with Chinese stimulus and the nascent recovery in the Eurozone should help the Japanese economy join the global recovery in the coming quarters.

Figure 3 Introducing QE Led to Increased Money Supply and Bank Lending for the Eurozone

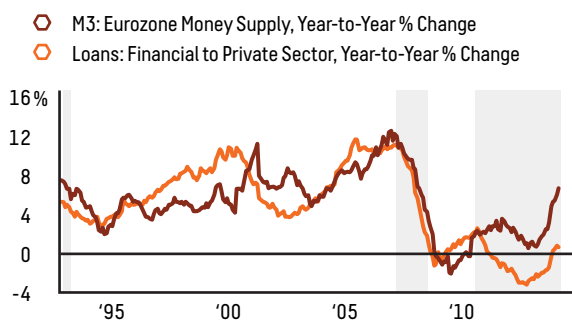

Source: LPL Research, European Central Bank, Haver Analytics 05/29/15

Shaded areas indicate recession.

Figure 4 Strong Response by Japan's Government and Central Bank Has Helped Its Deflation Reverse Course

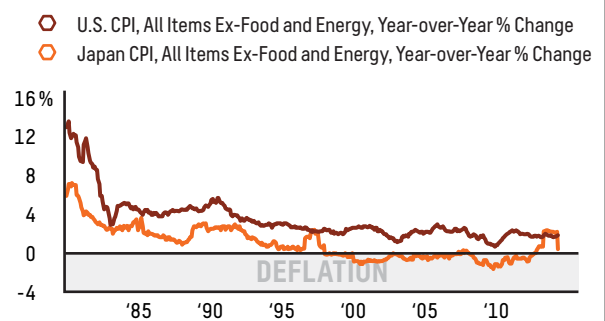

Source: LPL Research, BLS, MIC, Haver Analytics 05/29/15

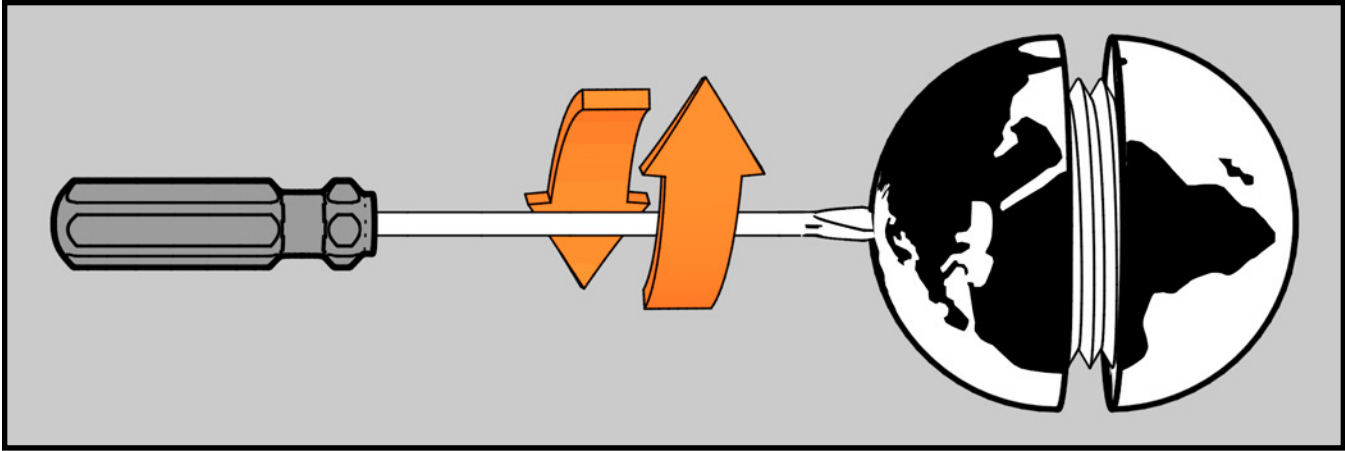

China:

Following the Steps to a Stable Growth Path

Chinese authorities have pulled out their power tools and put together monetary and fiscal stimulus for their economy. Chinese authorities have also eased regulations, which, in conjunction with stimulus, attempt to achieve a more stable growth path. China's economy clearly decelerated from the 10–12% pace of GDP growth seen in the first decade of the 2000s to near 7% today [Figure 5]; but risks of growth slowing even further remain, as China's property bubble continued to deflate during the first half of 2015.

However, with low inflation, as well as massive currency and fiscal reserves, China has the ability to help make the once-in-a-generation shift from a manufacturing-based export economy to a middle class-driven, consumer-oriented economy. As the Chinese economy transitions and other reliant economies adjust to the transition, economic volatility may increase across the globe. China's policy actions are still more like blunt instruments than precision tools.

Emerging Markets:

Using a Variety of Tools to Increase Growth Rates

Economies in emerging markets (EM), particularly Asia, continue to grow faster than developed markets [Figure 6], driven by policy reforms and favorable demographics. In the past 15 years, EM economies have built strong balance sheets, transforming from net debtors to net creditors and allowing those governments and central banks much more policy flexibility than they have had in the past. Political scandal and corruption is still a problem in some EM nations (Russia and Brazil are two high-profile examples). Other governments (Mexico and India) have been busy building better relationships with the business community, and are moving toward more open, market-friendly economies. Monetary policy in EM countries is often handled similar to someone using a sledgehammer where a ball peen hammer would suffice. More than 20 EM central banks cut interest rates so far this year, illustrating the breadth of key monetary stimulus. As inflation remains low, we expect more stimulus to feature prominently in the quarters ahead, which may provide an additional boost to EM economies.

Figure 5 China's Pace of GDP Growth Has Decelerated Since the Early 2000s to Near 7% in 2015

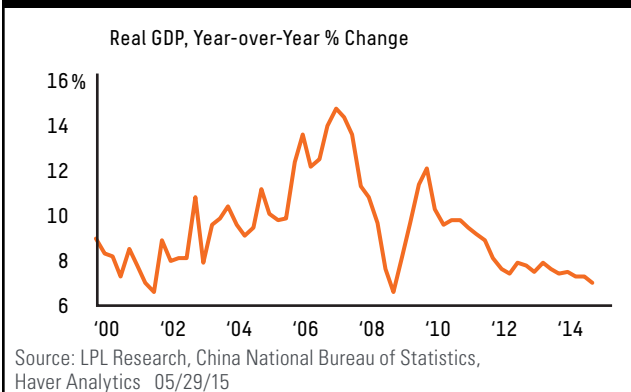
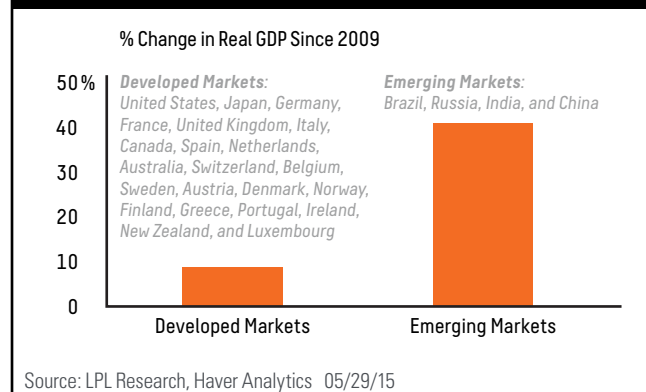

Figure 6 Growth Rate of EM Countries Has Surpassed Developed Markets in Recent Years



Past performance is no guarantee of future results.

ROTATE COUNTER- CLOCKWISE



Monetary Policies Drive Global Growth

LPL Research's Monetary Policy Impact Monitor measures changes in real GDP growth relative to other major economies (vertical axis) compared with a measure of each country's monetary policy (horizontal axis) as of the end of 2014. The 2012 values were added for the U.S., Eurozone, China, and Japan to give a sense of the natural rotation of countries at different stages of recovery. The monitor helps show the interaction between monetary policy and economic growth and provides a quick visual of the current global landscape.

Countries generally move counterclockwise: A weaker economy with tighter policy typically leads to policy-loosening action. If the policy is effective it will lead to improved growth and eventual policy-tightening action until the economic cycle leads to renewed weakness. The policy impact monitor shows how this rotation takes place relative to the other countries. Countries with trailing growth tend to be relatively more aggressive about monetary policy. Ideally, countries want to be able to sustain healthy growth with minimal central bank intervention.

Breaking Down the Rankings

For the growth axis, real GDP for the 20 largest global economies over a two-year period was compared with the two-year period five years prior. Countries were then ranked (higher number = better growth) and the average country was given a value of 0. For example, the U.S. grew at an annualized real rate of 2.2% from 2005–2007 and 2.3% from 2012–2014, which is a 4% increase in its growth rate. It was the only country to expand compared with the prior period over those time frames, so it received a top score (U.S. '14).

For the monetary policy axis, we looked at three measures of monetary policy: the eight-year change in each country's key policy rate (to fully capture current versus prerecession values), year-over-year real growth in M2 money supply, and the five-year change in currency values (versus the dollar for international currencies, the DXY Dollar Index for the dollar). Each of these values was ranked and then a weighted average was calculated for each country (the currency factor given less weight than the others since it is a less direct reflection of policy). The overall averages were re-ranked with the average country receiving a 0.

LPL RESEARCH'S MONETARY POLICY IMPACT MONITOR TOP 10 GLOBAL ECONOMIES*

TIGHTER POLICY

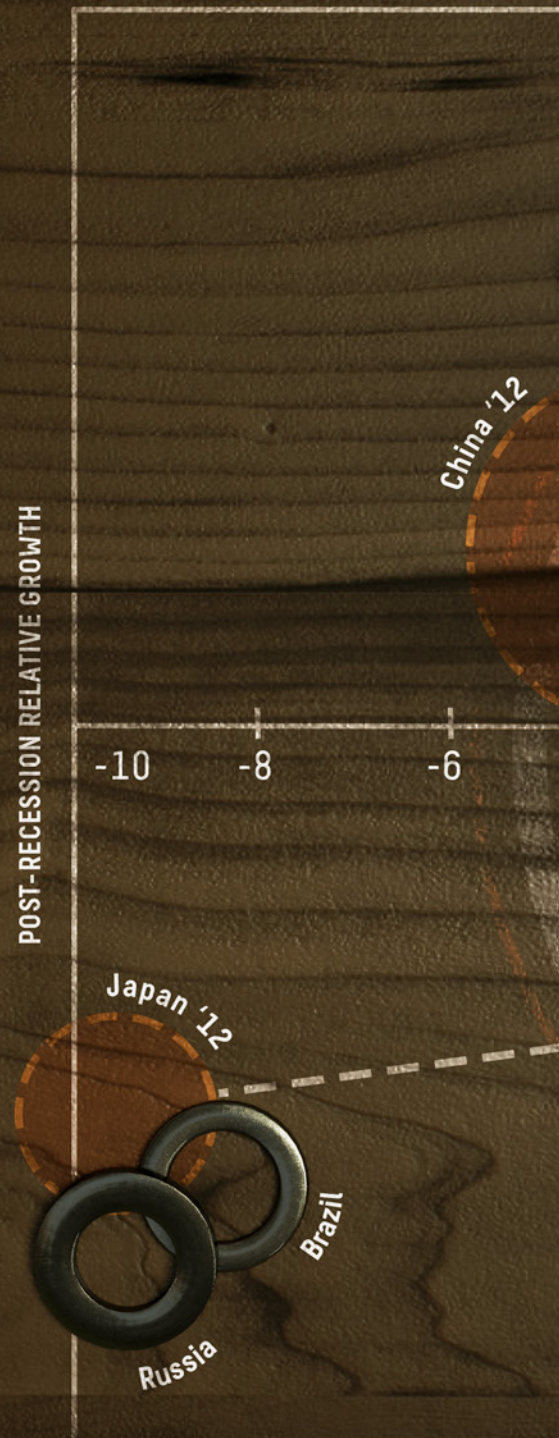

Sources: LPL Research, International Monetary Fund, Haver Analytics 05/29/15

*While 20 economies were used to establish a statistical baseline, only the 10 largest economies are shown.

○ SIZE OF CIRCLE REPRESENTS RELATIVE SIZE OF GDP IN 2014

○ SIZE OF CIRCLE REPRESENTS RELATIVE SIZE OF GDP IN 2012



STOCKS



TAKE NOTE:

BATTERIES NOT INCLUDED

Stocks on Track to Produce
Desirable Year-End Return

We remain confident in our 5–9% total return forecast for the S&P 500 for 2015, although reaching that target will require a power boost from corporate America. Our forecast is in line with the long-term average range of a 7–9% annual gain for stocks, based on the S&P 500 Index, since WWII. Our forecast is based on expected mid-single-digit earnings per share (EPS) growth for S&P 500 companies, supported by improved global economic growth, stable profit margins, and share buybacks in 2015, with limited help from valuation expansion.

The S&P 500 Index is on track to meet that forecast by year-end, having returned 3.5% year to date through the end of May 2015. However, headwinds that emerged early in 2015 mean getting there will require fresh batteries to fuel a second half charge.

The Instruction Manual for an Earnings Rebound

We expect the power boost for stocks to come from an earnings rebound, which likely requires some improvement in U.S. economic growth after the unexpected soft patch in early 2015. S&P 500 earnings hardly showed much spark during the first quarter of 2015, growing just 2% versus the prior year period. Earnings need more support to overcome the two biggest sources of resistance: lower oil prices and the strong dollar, which have only recently begun to ease.

The instruction manual for how to assemble our mid-single-digit earnings growth target includes several steps, none of which are easy:

- 1. Improve economic growth.** We expect better growth over the balance of 2015 following a subdued first quarter.
- 2. Stabilize (or increase) oil prices.** Oil price stability would help mitigate the energy sector's drag on S&P 500 earnings, estimated at about 6% in the first quarter of 2015.
- 3. Pause the U.S. dollar rally.** The strong U.S. dollar caused an estimated mid-single-digit percent earnings reduction in the first quarter of 2015 due to the negative impact on revenue earned overseas in foreign currencies.
- 4. Maintain or expand profit margins.** We believe corporate America may be able to maintain lofty profit margins, supported by stellar efficiency, only modest upward wage pressures, low borrowing costs, and still low commodity prices.
- 5. Continue heavy share buyback activity.** Share buybacks contributed 3% to S&P 500 earnings in 2014, a trend that we expect to continue due to strong corporate balance sheets.

Our favorite leading indicator for earnings growth is the Institute for Supply Management's (ISM) Purchasing Managers' Index (PMI). A sharp downshift in oil sector capital expenditures and a strong dollar pulled the index from an August 2014 peak of 58.1 to its May 2015 value of 52.8. However, we believe the impact has already been factored into forward earnings expectations.

Waiting for the Glue to Dry

The two big earnings headwinds for the first quarter of 2015, energy and the U.S. dollar, are starting to abate. Low oil prices have been a significant drag on energy sector earnings, which are expected to drop 56% in 2015 [Figure 7]. We expect oil prices may move gradually higher during the next six months, supported by slowing production volumes and reduced future production capacity (rig count and capital spending reductions), which position the energy sector to potentially outperform in the second half of 2015.

Although the sharp rise in the dollar has been a drag on earnings, history shows stocks have actually performed well during strong dollar environments. On average, the S&P 500 gained 11.2% in the year following a period in which the dollar increased over the prior 12 months. The average stock gain increases to 18.0% when the dollar is up by 10% or more (using data back to 1980). Stock

market weakness could accompany a surging dollar if driven by an accelerated Fed timetable for rate hikes or a related spike in market-based interest rates. We believe the risk of either event occurring is low.

Delicate Materials Included in Fed Package, but the Risk Is Manageable

Further gains for stocks during the second half of the year will require investors to overcome their interest rate anxiety. We expect the Fed to hike interest rates in late 2015 for the first time since June 2006.

Some volatility around the first Fed rate hike in an economic cycle is normal. Figure 8 (page 16) shows the performance of the S&P 500 around the 9 initial rate hikes after the end of each recession since the end of WWII, highlighting the recent dates (1983, 1994, and 2004) and the average. The S&P 500 moved higher 5 out of 9 times 3 months after an initial rate hike, but performance improved over time. The S&P 500 increased 7 out of 9 times over the following 6 months after a first Fed rate hike with an average gain of 4.2%. We expect the pace of Fed rate hikes to be gradual; therefore, we do not see the potential start of interest rate hikes as a big risk to the stock market over the balance of the year.

Upgrading to the Enhanced Model: This Bull Market Has a Longer Life

We believe the now six-year-old bull market has a good chance of reaching its seventh birthday (in March 2016), which would mark the third-longest bull market since the end of WWII, trailing only the post-war bull market (June 13, 1949 to August 2, 1956) and the 1990s bull market (October 11, 1990 to March 24, 2000). While a lot of pieces must come together for the S&P 500 to reach our return target for the year, the most important piece for the bull market to continue is the absence of a recession.

We use the Five Forecasters, our favorite leading indicators for evidence of an economic downturn that could cause the bull market to come apart, as a warning system of a recession. These five data series, of economic, financial market, and technical factors (shown in the Five Forecasters table on page 5), have a significant historical record of providing a warning signal that the economy is transitioning into the late stage of the economic cycle and recessionary pressures may be mounting. The Five Forecasters are currently suggesting a low probability of a near-term recession. Thus, we expect the continuation of the bull market into 2016.

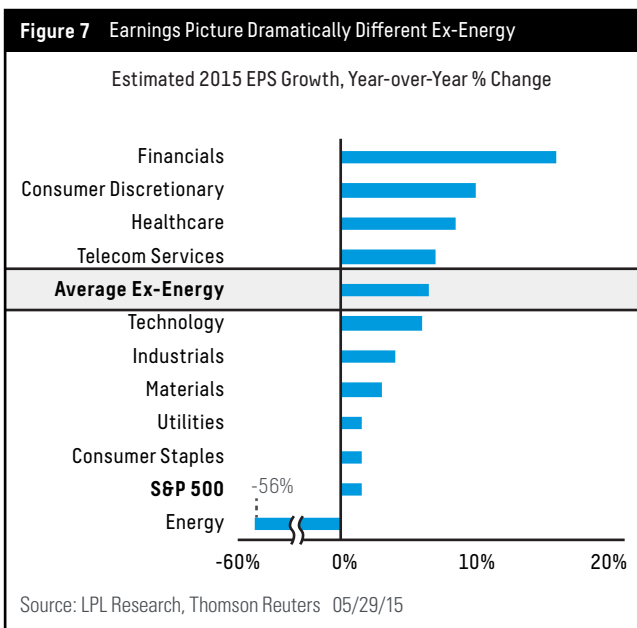

Because of its narrow focus, sector investing will be subject to greater volatility than investing more broadly across many sectors and companies.

Past performance is not indicative of future results. All indexes are unmanaged and cannot be invested into directly.

Sector performance is represented by S&P 500 subindex data.

Figure 8 Stocks Have Historically Managed Start of Fed Rate Hike Campaigns Effectively

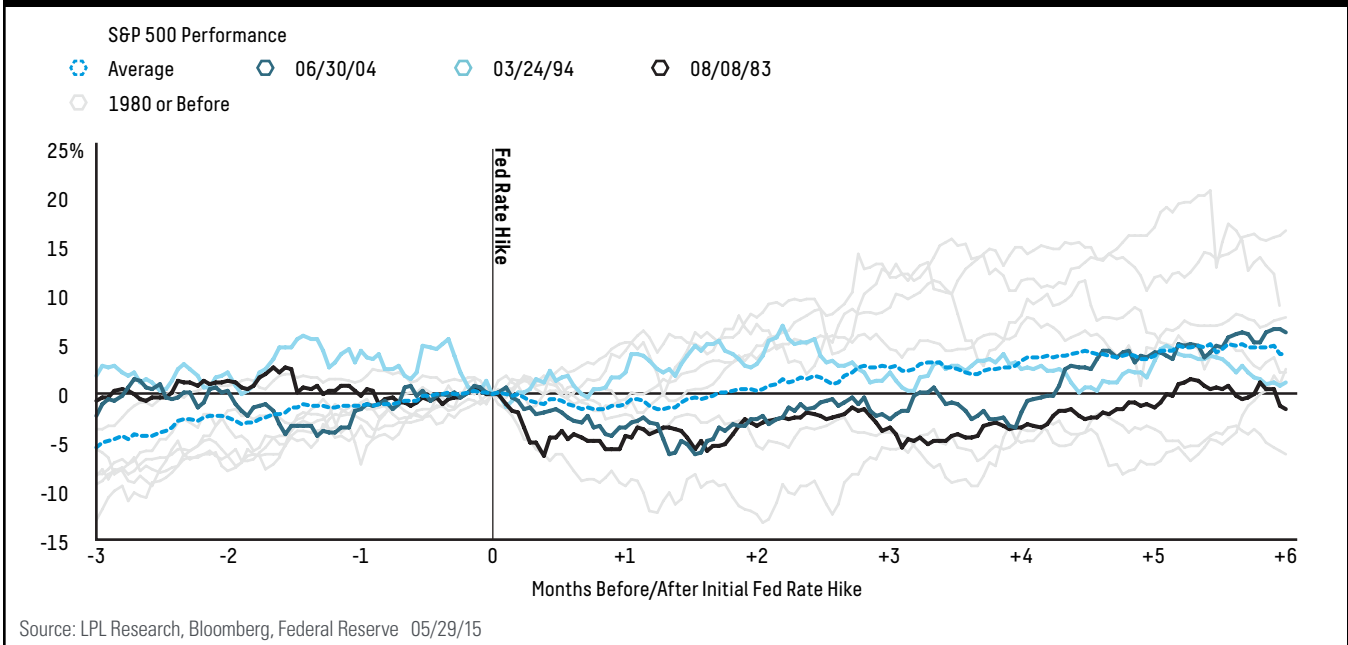

Data are based on price indexes. Dates indicate the start of the initial rate hike after the end of each recession.

Past performance is not indicative of future results. All indexes are unmanaged and cannot be invested into directly.

Stock market pullbacks (5–10% decline), or the occasional correction (10–20% decline), typically become more likely during the latter half of the business cycle. Pullbacks and corrections have been rare in recent years. Nearly four years have passed since the last correction (October 3, 2011), and only three pullbacks have occurred since September 2012. Over the past 12 months, bouts of brief sell-offs have become more common, in-line with the historical trend to see more volatility over the second half of the business cycle; but potentially higher volatility in the second half should not prevent stocks from achieving our return target.

Don't Anchor to Valuations

Despite a good fundamental foundation, stock valuations are not providing much support. The trailing price-to-earnings ratio (PE) of the S&P 500 Index stands at 17.6 (as of the end of May 2015), which is above the long-term average of 15.1 dating back to WWII, but is reasonable when compared with the post-1980 average of 16.4 [Figure 9].

Several factors suggest stocks can build on year-to-date gains even at current valuation levels:

- Low inflation increases the value of future earnings and helps keep interest rates low, which increases the value of future earnings and also the relative attractiveness of stocks versus bonds.

- Temporary factors, such as lower oil prices and U.S. dollar strength, are depressing earnings, making stocks temporarily appear more expensive.
- Earnings estimates for the coming year may be too low due to energy cost savings and the severity of earnings estimate cuts in the energy sector.

Figure 9 Valuations Are Only Slightly Above Post-1980 Average and Not Excessive in Our View

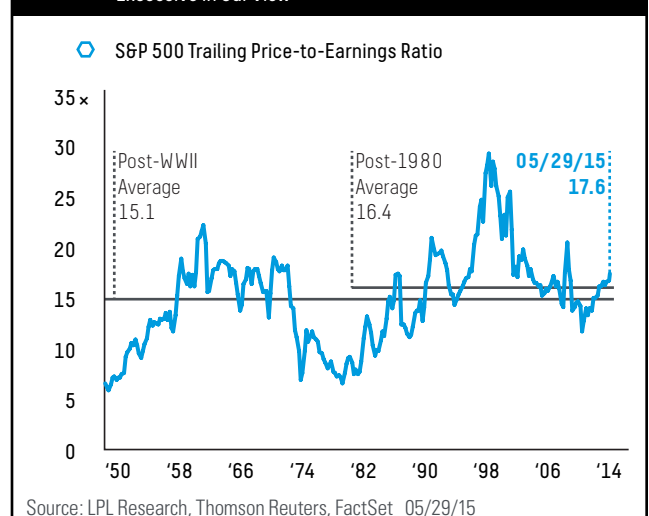

Past performance is not indicative of future results. All indexes are unmanaged and cannot be invested into directly.

The PE ratio (price-to-earnings ratio) is a valuation ratio of a company's current share price compared with its per-share earnings. A high PE suggests that investors are expecting high earnings growth in the future, compared with companies with a lower PE.

Rotate into Position

We continue to believe U.S. stocks should make up the bulk of most assembled portfolios, but do see a place for increasing allocations to international equities, particularly emerging markets. EM valuations remain attractive, with the MSCI EM Index trading at a 28% discount to the S&P 500 Index, as measured by the forward PE, compared to the average long-term discount of 21%. By this measure, EM valuations are still attractive relative to history and have room to rise.

EM equities, one of our favorite investment ideas for 2015, are also supported by solid economic growth, monetary stimulus, policy reforms, and financial strength. Most countries have changed from net debtors to net creditors, which bodes well for countries less reliant on

foreign investment to fund imports. Central banks are employing monetary stimulus (QE) to position economies for sustainable long-term growth and allowing exports to be boosted by weaker currencies. Potential Fed rate increases may drive divergences in country performance but present a manageable risk for EM equities overall, in our view.

Charging Ahead

Stocks are likely to remain the primary driver of diversified portfolio returns over the second half of 2015. Returns are dependent on an earnings recharge to reach full potential. With additional support from corporate America, we expect stocks to add to first half gains over the remainder of 2015 and the six-year-old bull market to power toward its seventh birthday in March 2016.

International and emerging markets investing involves special risks, such as currency fluctuation and political instability, and may not be suitable for all investors.

|  How to Invest | | |
|--|---------------------------------------|---|
| ✓ | LARGE CAP U.S. STOCKS | Despite some headwinds from a stronger dollar, scale, strong balance sheets, and pricing power trigger potential strong outcomes. |
| ✓ | CYCLICAL GROWTH STOCKS | Companies in the industrial and technology sectors are positioned to ride improving economic growth to better earnings and price returns. |
| ✓ | EMERGING MARKET STOCKS | Favorable valuations, strong demographic trends, and potential for stimulus to drive improved growth. |
| ✓ | DEVELOPED INTERNATIONAL STOCKS | The benefits of aggressive monetary policies should drive accelerating economic growth across Europe and Asia. |
| ✗ | U.S. DEFENSIVE STOCKS | Improving economic growth favors more cyclical equity sectors. |
| ✗ | INTEREST RATE-SENSITIVE STOCKS | The backdrop of potential Fed rate increases poses headwinds. |

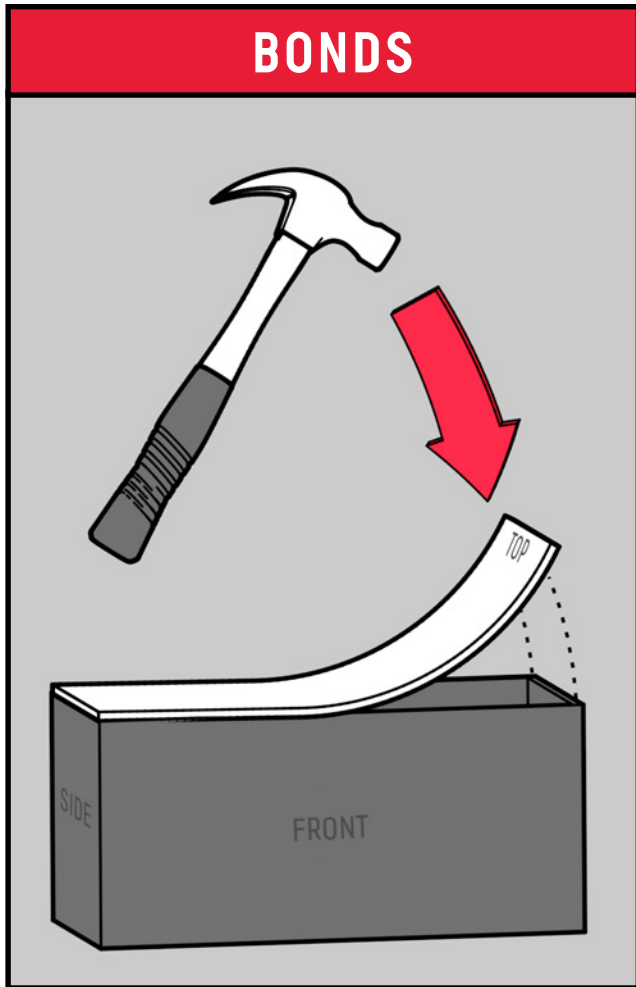

TAKE CAUTION:

HAMMER FLAT

Bond Returns Expected to Remain Flat

Bonds are subject to market and interest rate risk if sold prior to maturity. Bond values and yields will decline as interest rates rise and bonds are subject to availability and change in price.

We continue to expect roughly flat bond returns for 2015, as the choppy market environment witnessed over the first half of 2015 continues. The challenging, low-return environment confronting bond investors is likely to persist, and a slowdown in performance—even for sectors that fared well over the first half of 2015—appears probable.

We still expect a modest rise in bond yields over the course of 2015; but an increase of 0.25% to 0.50% in the 10-year Treasury yield, the lower half of our initial forecast, appears more likely due to the persistence of low inflation. An increase of 0.75% in 10-year Treasury yields is possible, but a low probability, in our view. Disappointing first quarter economic growth and a later start to Fed rate hikes, with a slower pace of additional hikes likely, mitigates the risk of a greater rise in interest rates.

Crossed Wires

Cross currents continue to buffer the bond market, leading to a push and pull on bond prices [Figure 10]. Concerns over a sluggish start for the U.S. economy in 2015 have recently given way to better growth expectations over the second half. European economic growth is on the path to improvement but durability is uncertain. Fading U.S. dollar strength, along with oil price stability, bodes well for a better economic performance and higher inflation expectations; however, here too uncertainty lingers over the permanence of recent stability. Ultimately we expect better economic performance to persevere, which coupled with the onset of Fed rate hikes, may lead to a modest rise in bond yields.

Figure 10 An Up and Down 2015 So Far

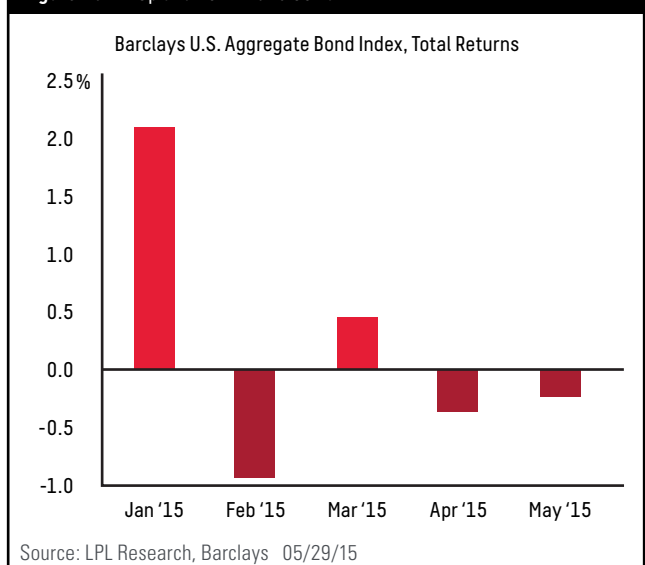

Past performance is not indicative of future results. All indexes are unmanaged and cannot be invested into directly.

Safety First

Aside from challenging fundamental factors, valuations remain expensive across the bond market. The inflation-adjusted yield of the 10-year Treasury note remains depressed relative to the historical average. This is especially noteworthy over the past 10 years—a period of generally expensive bond valuations [Figure 11]. Although inflation may increase only slowly, it reflects just how expensive high-quality bonds are. The lesser the inflation-adjusted yield, the more expensive valuations are, and vice versa. Even if interest rates remain stable and do not rise, expensive valuations suggest caution when investing in bonds.

A market-friendly Fed is largely factored into current market pricing, as Fed rate hike expectations remain notably below official Fed forecasts [Figure 12]. The fed funds futures market expects not only a later start to rate hikes, but also a slower pace of rate increases.

Futures also indicate the Fed may not return to a normal 3.75% overnight borrowing rate over the next 10 years. Such implied expectations are overly pessimistic in our view, but also illustrate the sharp contrast between market expectations and Fed guidance on future rate increases. A near-term return to a recession, which we view as unlikely, would probably be needed to reduce Fed expectations further. In sum, much of the good news about a slow and gradual pace of rate hikes is largely factored into current bond prices. Therefore, further bond price gains from dovish Fed expectations are unlikely and remove—or at least greatly reduce—another source of potential bond market strength.

Figure 11 Bond Valuations Remain Very Expensive

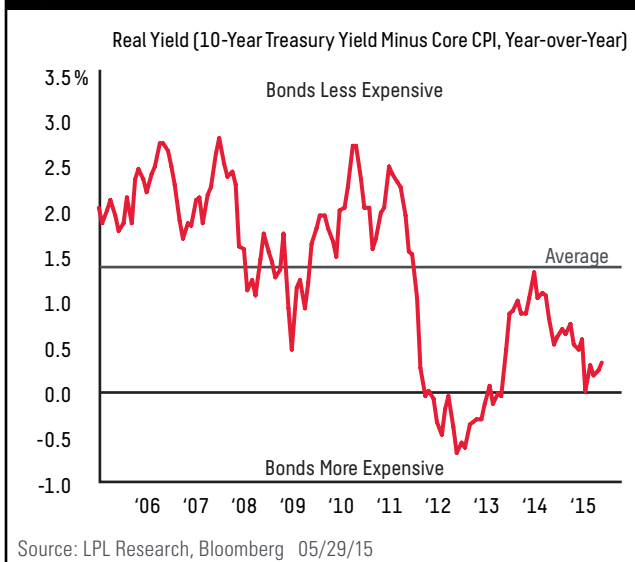

Past performance is not indicative of future results. All indexes are unmanaged and cannot be invested into directly.

Government bonds and Treasury bills are guaranteed by the U.S. government as to the timely payment of principal and interest and, if held to maturity, offer a fixed rate of return and fixed principal value. However, the value of fund shares is not guaranteed and will fluctuate.

Incorporating International Factors

Beauty is in the eye of the beholder, and overseas demand is likely to stay elevated as yield differentials between U.S. Treasuries and overseas government bonds remain near all-time historically wide levels [Figure 13]. The rise in longer-term interest rates may be restrained by foreign demand, which continues to look to U.S. Treasuries for additional yield.

Figure 12 Rate Hike Expectations Remain Notably Below Fed Forecasts

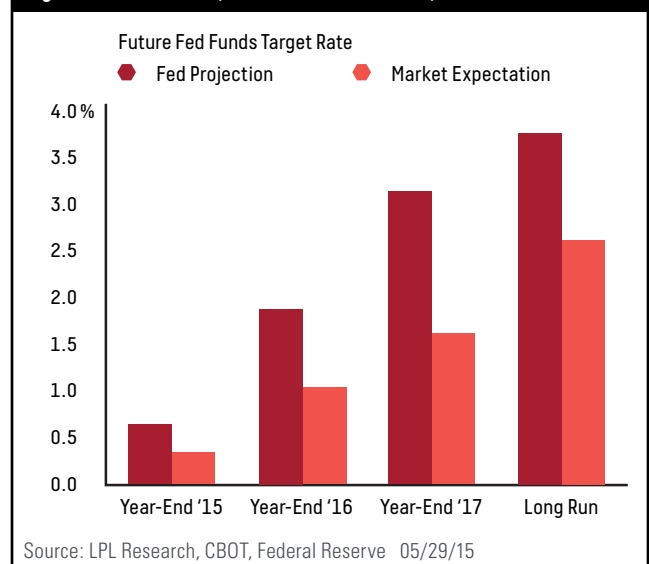

Long run is defined as five years.

Figure 13 U.S. Treasury Yields Remain the Highest Among the Seven Largest Developed Countries

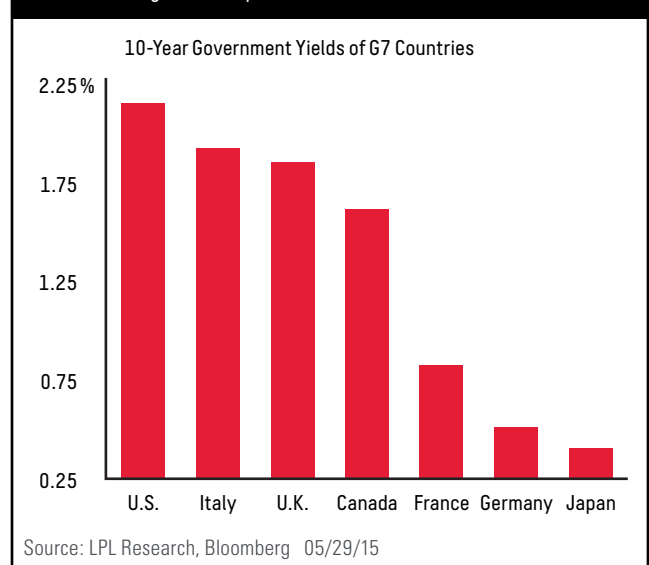

Past performance is not indicative of future results. All indexes are unmanaged and cannot be invested into directly.

Figure 14 Further Improvement in Valuations Is Likely Limited

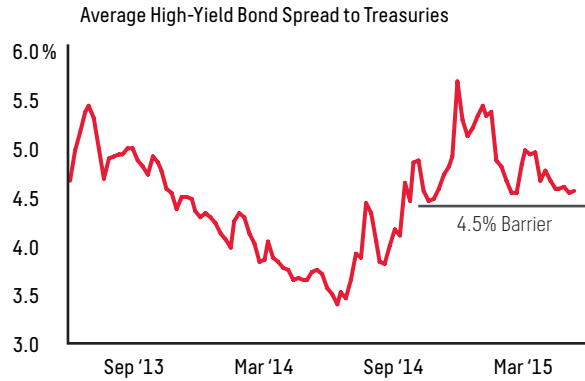

Source: LPL Research, Barclays 05/29/15

Past performance is not indicative of future results. All indexes are unmanaged and cannot be invested into directly.

Figure 15 Municipal Valuations Remain Attractive

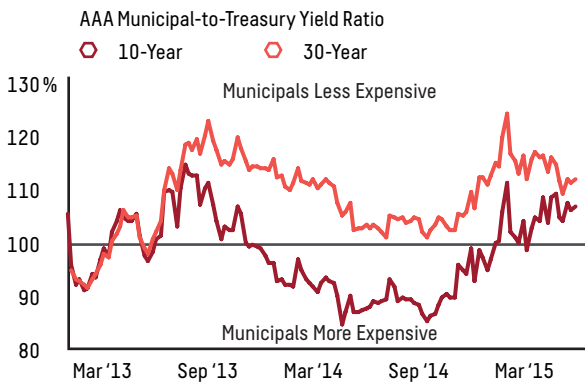

Source: LPL Research, MMA, Bloomberg 05/29/15

Past performance is not indicative of future results. All indexes are unmanaged and cannot be invested into directly.

Different agencies employ different rating scales for credit quality. Standard & Poor's (S&P) and Fitch both use scales from AAA (highest) through AA, A, BBB, BB, B, CCC, CC, C to D (lowest). Moody's uses a scale from Aaa (highest) through Aa, A, Baa, Ba, B, Caa, Ca to C (lowest).

Figure 16 Refinancing Is Running Well Above Normal

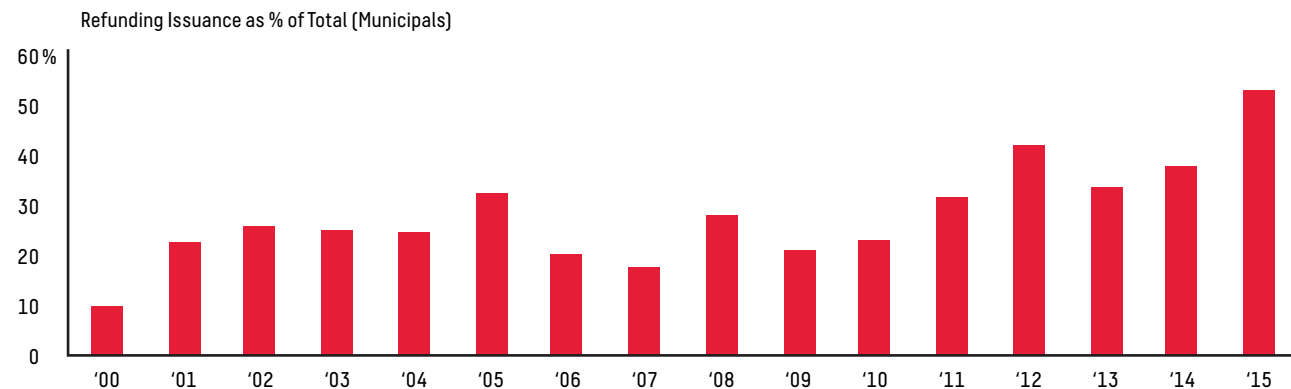

Source: LPL Research, *The Bond Buyer* 05/29/15

Yields near multi-century lows (in some cases) and lower than U.S. bond alternatives keep us away from using high-quality international bonds. We find domestic fixed income opportunities offer better value. Emerging markets debt (EMD) offers a better risk-reward, but we remain neutral. After improvement in the first half of 2015, lower yields and higher valuations suggest total returns may slow. The sector may show greater sensitivity to rising interest rates as well as a potential Fed rate hike late in the year.

Investing in foreign and emerging markets debt securities involves special additional risks. These risks include, but are not limited to, currency risk, geopolitical and regulatory risk, and risk associated with varying settlement standards.

A Tricky Assembly

Assembling a portfolio for today's challenging fixed income environment is difficult at best. A lack of opportunity, high valuations, low yields, and the prospects of rising interest rates argue for a defensive stance. A low-return environment is likely to dominate bond markets for the rest of 2015 and beyond. Managing risks, while positioning for modest returns, will require a delicate balancing act. We believe a combination of higher-yielding bonds along with intermediate-term high-quality bonds is potentially the right pairing for the job.

In an environment of low returns, higher-yield investments should remain a focus. Here too, however, some caution is warranted, and yield spreads between high-yield bonds and Treasuries have contracted over the first half of 2015 [Figure 14], as measured by the Barclays High Yield Bond Index and five-year Treasury yield. The average yield spread remains near 4.5%, a level that has halted further improvement among high-yield bonds in the past. Given the prospect of a modest

increase in default rates, it is unlikely high-yield bond valuations return to 2014 heights; however, the yield advantage over high-quality bonds remains significant and stands out in a low-yield world. Defaults are likely to remain low by historical comparison, as corporate issuers' ability to repay debt obligations remains strong.

We continue to find municipal bonds among the more attractive high-quality bond options. Municipal bonds lagged their taxable counterparts over the first five months of 2015, as measured by the Barclays Municipal Bond Index, which returned 0.5% over the time period compared with the 1.2% for the Barclays Aggregate Bond Index, but the silver lining was more attractive valuations [Figure 15]. Valuations—as measured by municipal-to-Treasury yield ratios—remain near the cheaper side of a two-year range. Overall yields remain low by historical comparison, but more attractive valuations might provide better price protection in the event that interest rates rise. During the late April to early May 2015 bond sell-off, municipal bonds proved more resilient to rising interest rate pressures.

Increasing supply remains a lingering headwind for municipal bonds. New issuance is running approximately 20–30% greater than the pace of 2013 and 2014. Rising new issuance raises the risk of a supply surge that may pressure bond prices. However, a closer look at the

increase in municipal bond new issuance shows that municipal issuers are simply taking advantage of lower interest rates to refinance existing debt obligations. Refinancing volume makes up a record percentage of total issuance [Figure 16]. As a result, net growth of the municipal bond market is likely to be negligible at best for 2015, as issuance for new projects remains light due to still tight state and local budgets. Over the longer term, a favorable supply-demand dynamic in the municipal bond market could remain intact.

Intermediate-term bonds provide an attractive blend of diversification benefits and yield without significant interest rate risk, such as that posed by long-term bonds. On the flip side, the significantly lower yield on short-term bonds—coupled with their reduced ability to provide diversification benefits in the event of a stock market sell-off—reduces their attractiveness. We remain focused on intermediate-term bonds.

High-yield/junk bonds are not investment-grade securities, involve substantial risks, and generally should be part of the diversified portfolio of sophisticated investors.

Municipal bonds are subject to availability, price, and to market and interest rate risk if sold prior to maturity. Bond values will decline as interest rate rise. Interest income may be subject to the alternative minimum tax. Federally tax-free but other state and local taxes may apply.

|  How to Invest | | |
|--|--|---|
| ✓ | INTERMEDIATE-TERM HIGH-QUALITY BONDS | Provide an attractive blend of diversification benefits and yield without the significant interest rate risk of longer maturity alternatives. |
| ✓ | INVESTMENT-GRADE CORPORATE AND HIGH-YIELD BONDS | Higher yields and strong corporate balance sheets buffer against an environment of low returns and rising rates. |
| ✓ | MUNICIPAL BONDS | Tax benefits and appealing valuations make municipals among the most attractive high-quality bond alternatives. |
| ✗ | LONG-TERM HIGH-QUALITY BONDS | Backdrop of rising rates impedes this highly interest rate-sensitive segment. |
| ✗ | INTERNATIONAL DEVELOPED MARKET BONDS | Many international countries' debt trading at historically low yields offers limited return potential. |

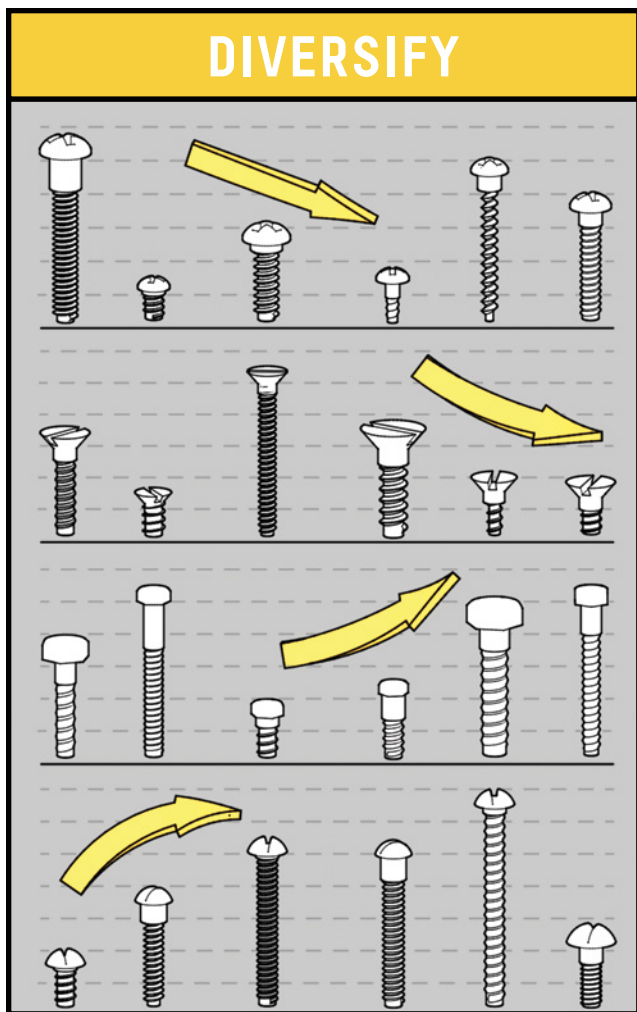

WHAT'S INCLUDED:

THE NUTS & BOLTS OF DIVERSIFICATION

Still a Vital Tool in Building Portfolios

There is no guarantee that a diversified portfolio will enhance overall returns or outperform a nondiversified portfolio. Diversification does not protect against market risk.

Almost any complex product assembly involves a vast array of parts and component pieces. Washers, bolts, nuts, screws, and many other pieces come in a diverse range of sizes, colors, and shapes, which reflect each component's unique and distinct role in the assembly. And when assembled correctly—based on the strict instruction manual guidelines—the collection transforms from a box full of pieces to a unique final product.

In investing, finding the right pieces and combining them optimally is also vital in transforming a pile of diverse asset classes and investments into a cohesive portfolio. Each investment has an important role and is designed to complement and enhance other investment ideas to achieve an optimal portfolio. The assembly of disparate investment ideas to a well-constructed portfolio is what separates mere investing from portfolio management. The very connection points—the glue—that binds investment ideas into a portfolio context is the powerful concept of diversification.

However, despite the near universal acceptance of the importance of diversification, having a diversified portfolio does not automatically mean investors will outperform or gain value in risk reduction.

This was best demonstrated in 2014, when despite a sixth consecutive year of stock market gains, some investors might have lagged, as most segments of global financial markets failed to keep pace with many of the popular domestic stock market indexes. The broad S&P 500 Index and the Nasdaq Composite Index finished the year up 13.7% and 14.8%, respectively, and solidly outperformed other diversifying asset classes, like small cap or international stocks, by wide margins [Figure 17]. Investors taught not to keep “all their eggs in one basket” and diversify their portfolios were left wanting more, as their investment performance trailed these broad U.S. benchmarks.

And 2014 is not a sole outlier, as diversification failed to benefit investors twice more in recent years. In fact, the S&P 500 Index has outperformed an equal-weighted portfolio of the most common equity asset classes used to diversify (mid cap, small cap, developed foreign, and emerging market stocks) by a combined average of roughly 5% in three of the past four years. Not since 1998 and the Asian Crisis, when international stocks suffered and small and mid cap stocks also underperformed, has such a large performance gap between the S&P 500 Index and the other segments of the global stock market existed.

So why not just invest in large cap stocks or the S&P 500 and abandon the notion of diversification? Simply

Figure 17 Large Cap U.S. Stocks Were a Standout in 2014

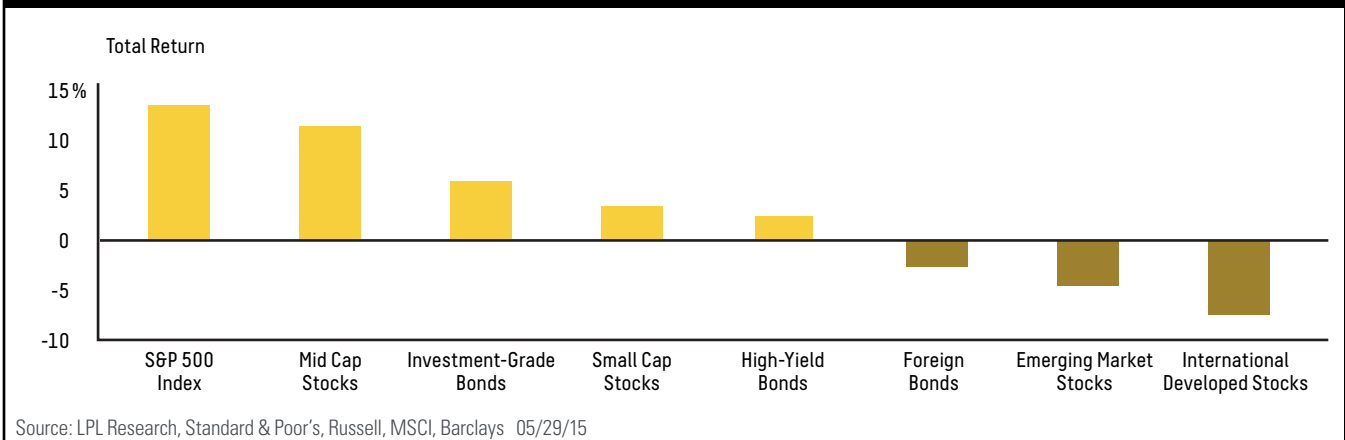

Data shown are as of 12/31/14. Asset class data shown are represented by the indexes listed in the Disclosure section.

Past performance is not indicative of future results. All indexes are unmanaged and cannot be invested into directly. Unmanaged index returns do not reflect fees, expenses, or sales charges. Index performance is not indicative of the performance of any investment.

put, to do so would be a mistake of overvaluing a short-term phenomenon over a long-standing investment axiom that benefits more than it hurts. In fact, over the past 20 years, the S&P 500 has only outperformed all other major asset classes (including small, mid, foreign developed, and emerging markets) 30% of the time, and it was the worst performing asset class 25% of the time. This demonstrates the importance of investing in at least several different types of investments. Diversification has historically worked and it remains the core tenet of portfolio strategy.

How vs. Why We Diversify

Though diversification has not recently provided the return enhancement and risk reduction that we have become accustomed to, it does not mean that diversification has not been effective. Dissecting *how* portfolios are diversified from *why* they are diversified

helps to showcase the areas in which diversification has continued to add value.

Citing modern portfolio theory, *how* we diversify is by assembling a combination of investments that display different and uncorrelated return behaviors, over time, and the desired result is a portfolio that offers a more stable and consistent pattern of returns. One way to illustrate this is by using the correlation of major asset classes to the S&P 500 over the last two years and the prior decade. The results are compelling. Major asset classes have, on average, had a lower correlation and thus a greater diversification benefit to large cap stocks [Figure 18].

Again, looking back to modern portfolio theory also explains the *why*—the desired result is a portfolio that has lowered risks without sacrificing return. From this perspective, diversification has not delivered the benefits that investors have sought. Examining batting averages (the percentage of quarters in which an investment outperformed the S&P

Figure 18 Dissecting the *How* from the *Why* of Diversification

| | Mid Cap Stocks | Small Cap Stocks | International Developed Stocks | Emerging Market Stocks | Commodities | Real Estate | Average |
|---------------------------------------|----------------|------------------|--------------------------------|------------------------|-------------|-------------|---------|
| 2002–2012 Correlation to S&P 500 | 0.89 | 0.94 | 0.89 | 0.79 | 0.42 | 0.71 | 0.77 |
| 2013–2014 Correlation to S&P 500 | 0.80 | 0.91 | 0.81 | 0.61 | 0.33 | 0.38 | 0.64 |
| 2002–2012 Batting Average vs. S&P 500 | 56% | 53% | 45% | 58% | 50% | 61% | 54% |
| 2013–2014 Batting Average vs. S&P 500 | 54% | 46% | 46% | 25% | 17% | 33% | 37% |

Source: LPL Research, FactSet 05/29/15

Data shown are as of 12/31/14. Asset class data shown are represented by the indexes listed in the Disclosure section.

Past performance is not indicative of future results. All indexes are unmanaged and cannot be invested into directly.

500 Index) helps to illustrate how diversifying asset classes have struggled as of late. Over the last two years, the batting averages have fallen dramatically from the lofty levels of the previous decade [Figure 18].

This paradox between the *how* and the *why* makes answering the question of “has diversification worked?” difficult and creates an environment where investors doubt diversification’s value. The truth is that diversification has worked exactly as designed by providing uncorrelated behavior for portfolios, but the benefits haven’t materialized because the market conditions have favored large cap U.S. stocks over virtually all other equity investments. The real question, therefore, is not whether diversification works, but rather, when will the benefits return?

Searching for the Right Piece

The potential benefits of diversification are often cyclical, just like the nature of investments. During the past 15 years, a period that includes two recessions, diversification has been a benefit more often than it has

been a penalty [Figure 19]. The benefit, or penalty, of diversification can persist for long periods of time—often years. Since 2013, there has been a diversification penalty. Over time, we expect this condition to reverse, just as it has historically, and diversification may benefit investors once again.

While there is no single reason as to why diversification benefits do not materialize, the level of overall volatility seems to play an outsized role. By using the level of the VIX (an index that demonstrates the market’s expectation of 30-day volatility) as a proxy for volatility, when readings have been high (above 24), a diversified portfolio has outperformed the market 88% of the time, by an average of 5.7%, over the next year. In periods when volatility has been low, diversified investments have trailed the S&P 500 by a wide margin (almost 4%) [Figure 20].

There are several reasons why more volatile periods have led to an environment of strong returns for diversifying investments. Primarily, after elevated volatility, investors tend to seek the benefits of diversifying asset classes to help provide the risk mitigation properties of lower correlation. In addition, higher volatility also presents more return disparities among investments and thus potential for outsized return opportunities from diversifying investments. During the last few years, volatility has been at historically low levels, which creates a tough environment to garner the return benefits of diversification. Despite the recent years of weaker return benefits from diversification, the trend may be changing. Volatility appears to be poised to rise, which has already allowed for an improved environment for diversifying asset classes through the first half of 2015.

The New Diversification

Looking ahead, we believe portfolios will contain a much broader set of investment choices. While manufacturers of complex products may have gotten by with just a wrench and a hammer in the past, today’s investors need more than just stocks and bonds in their toolkits. Alternative strategies, and importantly, a more thematic approach to investing, are just a few interesting pieces to help diversify.

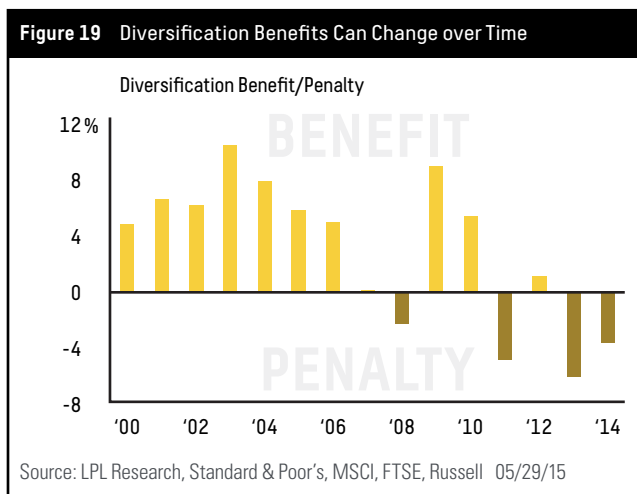

Data shown are as of 12/31/14.

The benefit vs. penalty shows the hypothetical behavior of a diversified portfolio consisting of 30% large cap stocks, 20% mid cap, 20% small cap, 10% developed foreign, 10% emerging markets, and 10% real estate.

Figure 20 During Periods of High Volatility, Diversified Portfolios Have Outperformed 88% of the Time

| VIX 2-Year Moving Average | Number of Months | Percentage of Months | Diversified Equity Portfolio vs. S&P 500 | |
|---------------------------|------------------|----------------------|--|-----------------|
| | | | Average Forward 1-Year Performance Benefit | Batting Average |
| Above 24 | 76 | 29% | 5.74% | 88% |
| Between 15 and 24 | 119 | 45% | -0.17% | 47% |
| Below 15 | 69 | 26% | -3.67% | 38% |

Source: LPL Research, CBOE, Zephyr 05/29/15

Data as of 12/31/14. Past performance is not indicative of future results. All indexes are unmanaged and cannot be invested into directly.





Alternative strategies offer uncorrelated return behavior to potentially help maximize a portfolio's diversification profile. There are many forms of alternative investment strategies, some of which appear poised to offer risk-return benefits (global macro and managed futures alternative strategies, as well as master limited partnerships [MLP]), and others that should continue to be avoided (commodities and traded real estate).

Diversifying with the more traditional tools of capitalization (large versus small), style (value versus growth), and region (U.S. versus global) continues to add great value, as does the usage of alternative strategies. However, the benefits have been steadily declining over the last 20 years, as more asset classes have become more correlated and volatility has been relatively low. By supplementing with a more thematic investment approach, portfolios may be poised to take advantage of some more targeted investment ideas.



Life around the world does not consider the nine style boxes as it happens—it just happens. There are some large themes that shape the world and will dictate which investments thrive within it. Among the many themes we are watching, some noteworthy ones include: the U.S. energy renaissance, the rise of the Millennials, and scarcity and sustainability.

Although there are many novel tools and techniques in the investing world, few are as tried and true as diversification. While its benefits do not materialize every year, as shown in the past two years, the long-term record of its value is unquestioned. Diversification, along with the patience and commitment to a financial plan, remains the very best weapon to weather volatile and uncertain market conditions.

🔑 How to Invest

| | | |
|---|---|---|
|  | GLOBAL MACRO ALTERNATIVE STRATEGIES | Diverging global economic backdrops benefit their macroeconomic analysis and forecasting. |
|  | MANAGED FUTURES ALTERNATIVE STRATEGIES | Cross-currents of strong currency and commodity trends offer opportunities for these momentum and pattern-following strategies. |
|  | MASTER LIMITED PARTNERSHIPS (MLP) | Benefit from the likely stabilization of oil prices. |
|  | COMMODITIES | Modest global demand and a stronger dollar limit upside. |
|  | TRADED REAL ESTATE | Headwinds from rising valuations and the backdrop of higher rates. |

🔑 Themes to Consider

| | | |
|---|------------------------------------|--|
|  | U.S. ENERGY RENAISSANCE | U.S. creates a new economic, social, and trade dynamic for global markets as we move toward energy independence. |
|  | RISE OF THE MILLENNIALS | How business is done is much different for this increasingly technology-focused and social media-oriented group. |
|  | SCARCITY AND SUSTAINABILITY | A resource-strained globe creates pockets of scarcity that, together with advances in sustainability, will shape future development. |

Alternative strategies may not be suitable for all investors and should be considered as an investment for the risk capital portion of the investor's portfolio. The strategies employed in the management of alternative investments may accelerate the velocity of potential losses.

Investing in MLPs involves additional risks as compared with the risks of investing in common stock, including risks related to cash flow, dilution, and voting rights. MLPs may trade less frequently than larger companies due to their smaller capitalizations, which may result in erratic price movement or illiquidity.

Global macro strategies attempt to profit from anticipated price movements in stock markets, interest rates, foreign exchange, and physical commodities. Global macro risks include, but are not limited to, imperfect knowledge of macro events, divergent movement from macro events, loss of principal, and related geopolitical risks.

Managed futures strategies use systematic quantitative programs to find and invest in positive and negative trends in the futures markets for financials and commodities. Futures and forward trading is speculative, includes a high degree of risk that the anticipated market outcome may not occur, and may not be suitable for all investors.

FINE-TUNING | KEEP YOUR MANUAL HANDY

“Some assembly required” is a daunting phrase. Moving from parts crammed into a shipping box to a fully assembled product is no easy task. But when is any accomplishment easy? It’s the hard work, a well-executed plan, and the final outcome that makes it worth it.

Often, however, after you have meticulously followed the instructions and completed all the steps, some leftover pieces remain. Doubt seeps in and you may ask yourself: Did you miss a step? Are these spare parts important? One thing is certain: having extra pieces, which come in the form of unknowns and discomforting questions, is all too common in investing.

As the U.S. economy closes out its sixth consecutive year of expansion in June 2015, investors should remain confident that the global economy has assembled the right mix of improved consumer spending, a more self-assured business environment, and investor optimism. The result may be a continuation of the business cycle that supports improving corporate profits, expanding global employment, and potentially rising stock prices. But several extra pieces remain that are still unknowns as to how they will fit into the final assembly, including how the market reacts to the Fed’s likely rise in interest rates and whether the accommodative monetary policies in Japan and Europe will finally take root and stabilize their still uncertain economic recoveries. Although the final placement of these extra pieces may still be undetermined, these factors will have considerable impact on the performance and viability of the global economy and the market’s final assembly.

With so many factors—and unknowns—putting it all together is difficult for investors. However, it can be eased considerably with the help of a great partner—your financial advisor—who serves as another set of hands to help hold, tighten, and align along the way. And we trust our *Midyear Outlook 2015: Some Assembly Required* is the investment instruction manual that will help guide your portfolio allocations through the remainder of this potentially volatile, but positively trending, economic expansion.



IMPORTANT DISCLOSURES

The opinions voiced in this material are for general information only and are not intended to provide or be construed as providing specific investment advice or recommendations for any individual security. To determine which investments may be appropriate for you, consult your financial advisor prior to investing. All performance referenced is historical and is no guarantee of future results. All indexes are unmanaged and cannot be invested into directly.

Economic forecasts set forth may not develop as predicted, and there can be no guarantee that strategies promoted will be successful.

Investing in stock includes numerous specific risks including: the fluctuation of dividend, loss of principal, and potential liquidity of the investment in a falling market.

Asset classes represented: Large Cap Stocks: S&P 500 Index; Mid Cap Stocks: Russell Midcap Index; Investment-Grade Bonds: Barclays U.S. Aggregate Bond Index; Small Cap Stocks: Russell 2000 Index; High-Yield Bonds: Barclays U.S. Corporate High-Yield Bond Index; Foreign Bonds: Barclays Global Aggregate ex-USD Index; Emerging Market Stocks: MSCI Emerging Markets Index; International Developed Stocks: MSCI EAFE Index Commodities: Bloomberg Commodity Index; Real estate: NAREIT All Equity REIT Index

The S&P 500 Index is a capitalization-weighted index of 500 stocks designed to measure performance of the broad domestic economy through changes in the aggregate market value of 500 stocks representing all major industries.

The Russell Mid Cap Index offers investors access to the mid cap segment of the U.S. equity universe. The Russell Mid Cap Index is constructed to provide a comprehensive and unbiased barometer for the mid cap segment and is completely reconstituted annually to ensure that larger stocks do not distort the performance and characteristics of the true mid cap opportunity set. The Russell Mid Cap Index includes the smallest 800 securities in the Russell 1000.

The Barclays U.S. Aggregate Bond Index is a broad-based flagship benchmark that measures the investment-grade, U.S. dollar-denominated, fixed-rate taxable bond market. The index includes Treasuries, government-related and corporate securities, MBS (agency fixed-rate and hybrid ARM pass-throughs), ABS, and CMBS (agency and non-agency).

The Russell 2000 Index measures the performance of the small cap segment of the U.S. equity universe. The Russell 2000 Index is a subset of the Russell 3000 Index representing approximately 10% of the total market capitalization of that index.

The Barclays U.S. Corporate High-Yield Index measures the market of USD-denominated, noninvestment-grade, fixed-rate, taxable corporate bonds. Securities are classified as high yield if the middle rating of Moody's, Fitch, and S&P is Ba1/BB+/BB+ or below, excluding emerging markets debt.

The Barclays Global Aggregate ex-U.S. Index is an unmanaged index considered representative of bonds of foreign countries.

The Institute for Supply Management (ISM) Purchasing Managers' Index is based on surveys of more than 300 manufacturing firms by the Institute for Supply Management. The ISM Manufacturing Index monitors employment, production inventories, new orders, and supplier deliveries. A composite diffusion index is created that monitors conditions in national manufacturing based on the data from these surveys.

The MSCI Emerging Markets Index is a free float-adjusted, market capitalization index that is designed to measure equity market performance of emerging markets.

The MSCI EAFE Index is a free float-adjusted, market-capitalization index that is designed to measure the equity market performance of developed markets, excluding the United States and Canada.

The Bloomberg Commodity Index is calculated on an excess return basis and composed of futures contracts on 22 physical commodities. It reflects the return of underlying commodity futures price movements.

The FTSE NAREIT All Equity REITs Index contains all tax-qualified REITs with more than 50 percent of total assets in qualifying real estate assets, other than mortgages secured by real property that also meet minimum size and liquidity criteria.

The Barclays Municipal High Yield Bond Index is comprised of bonds with maturities greater than one year, having a par value of at least \$3 million issued as part of a transaction size greater than \$20 million, and rated no higher than 'BB+' or equivalent by any of the three principal rating agencies. (The long and the short are subindexes of the Municipal Bond Index, based on duration length.)

The Nasdaq Composite Index measures all Nasdaq domestic and non-U.S.-based common stocks listed on the Nasdaq stock market. The index is market-value weighted. This means that each company's security affects the index in proportion to its market value. The market value, the last sale price multiplied by total shares outstanding, is calculated throughout the trading day, and is related to the total value of the index. It is not possible to invest directly in an index.

The DXY Dollar Index is a measure of the value of the U.S. dollar versus a basket of its major trade partners.

M2 money supply is a measure of a country's money supply that includes cash, checking and savings deposits, money market mutual funds, and other time deposits. For Australia and Brazil, only M1 money supply data was available, which only includes cash and checking deposits.

WWW.LPL.COM

Member FINRA/SIPC

THIS RESEARCH
MATERIAL HAS BEEN PREPARED
BY LPL FINANCIAL.

To the extent you are receiving investment advice from a separately registered independent investment advisor, please note that LPL Financial is not an affiliate of and makes no representation with respect to such entity.

Not FDIC/NCUA Insured
Not Bank/Credit Union
Guaranteed
May Lose Value
Not Guaranteed by Any
Government Agency
Not a Bank/Credit Union
Deposit

Printed on recycled paper containing 10%
post-consumer fiber.



RES #5106 0615 | Tracking #1-388787 (Exp. 06/16)

MADE IN THE
U.S.A.

 LPL Financial